

ARTURA

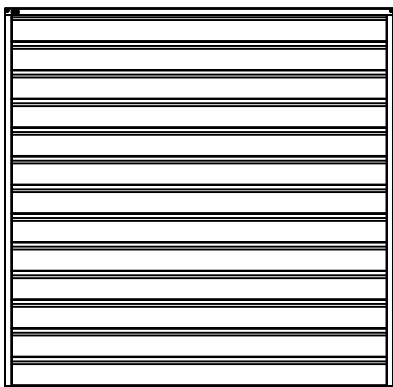

175300-1

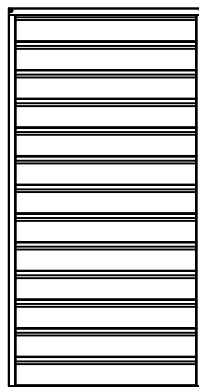

175310-1

1751.5



175301-1

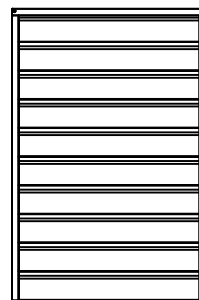

175311-1

1352.5

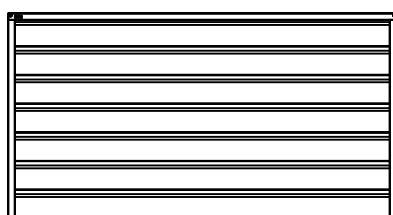

175302-1

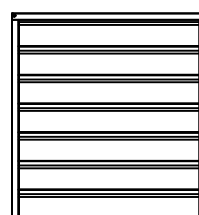

175312-1

953.5

1800.0

900.0

Tilbehør
Accessories
Zubehör
Accessoire
Onderdelen
Lisälaitteet
Tillbehör

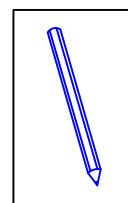
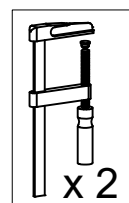
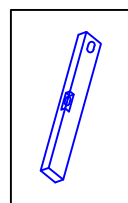
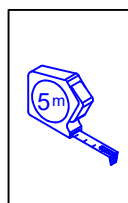
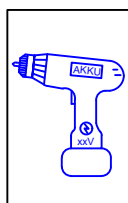
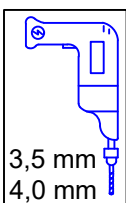
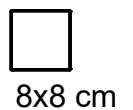
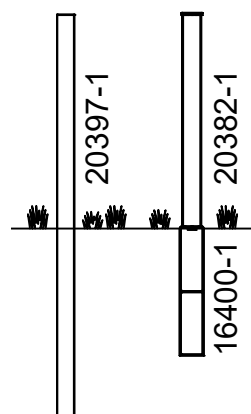
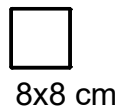
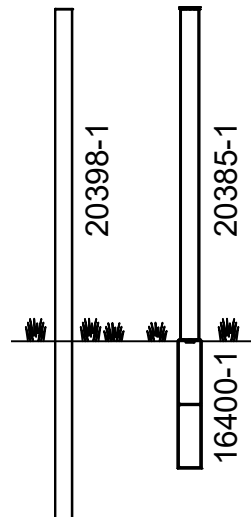
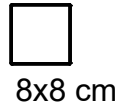
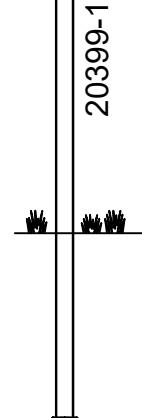

PLUS

PLUS A/S
Ådalen 13B
DK-6600 Vejen
phone: +45 7996 3333
web: www.plus.dk

175300-1

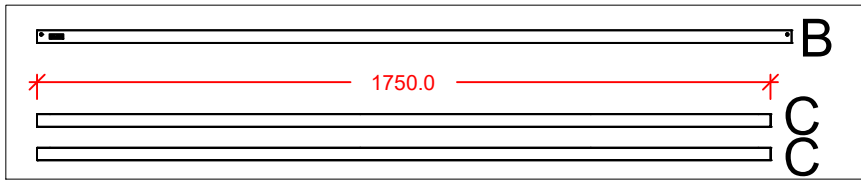

1 x 1753101

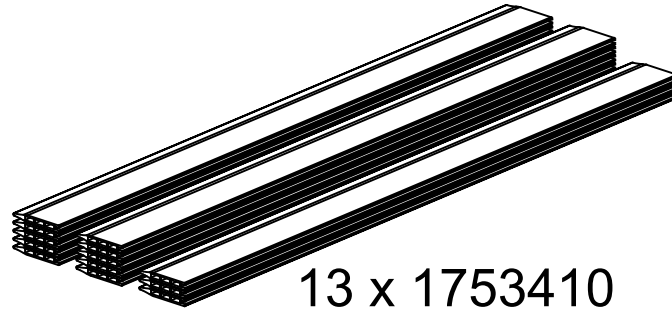
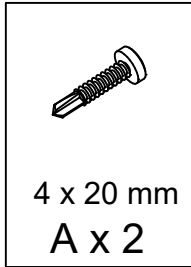

175301-1

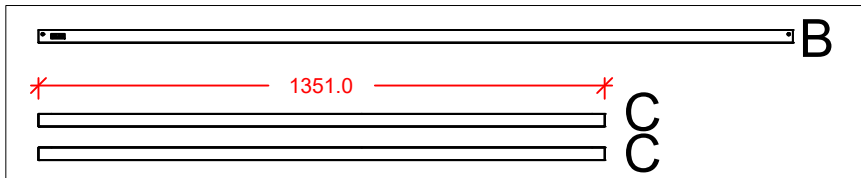

1 x 1753102

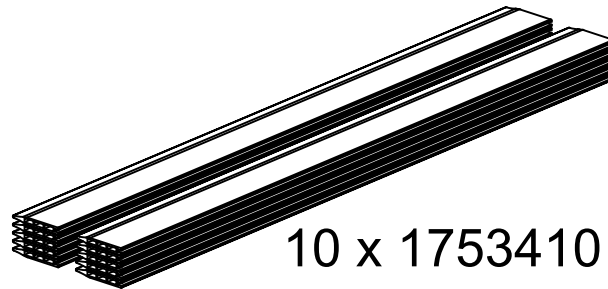
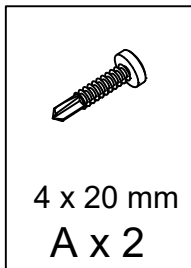

175302-1

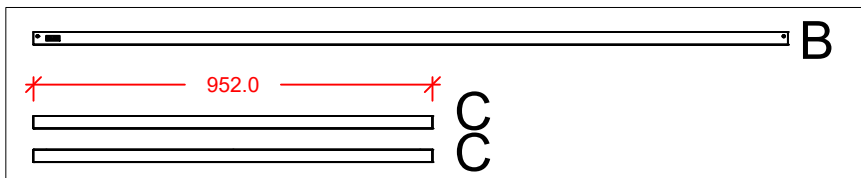

1 x 1753103

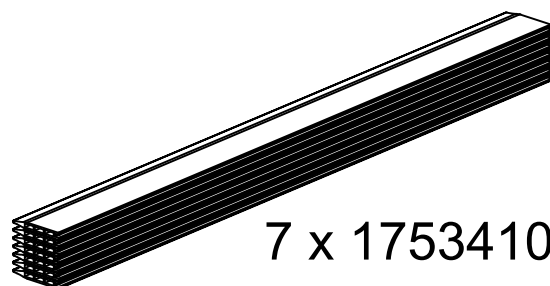
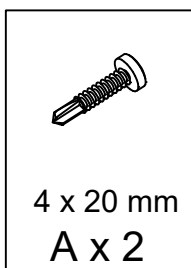

175310-1

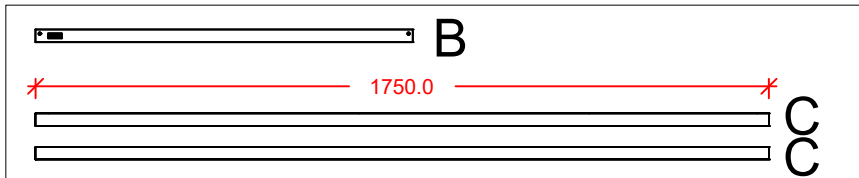

1 x 1753111

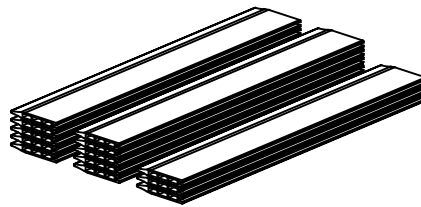
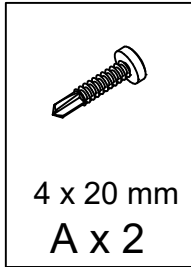

13 x 1753411

175311-1

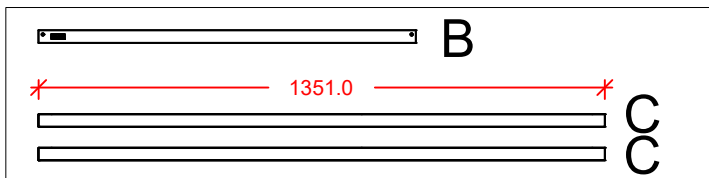

1 x 1753112

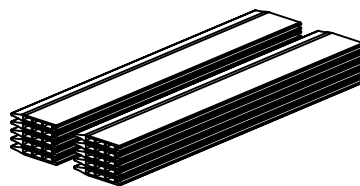
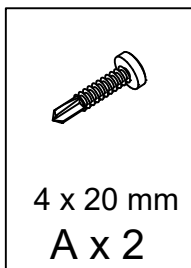

10 x 1753411

175312-1

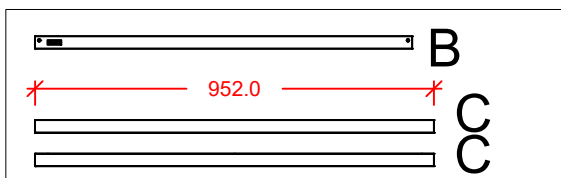

1 x 1753113

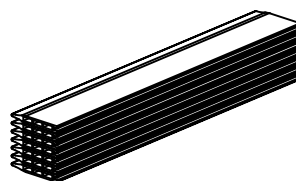
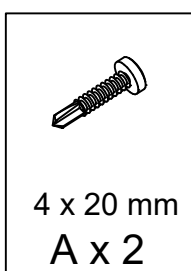

7 x 1753411

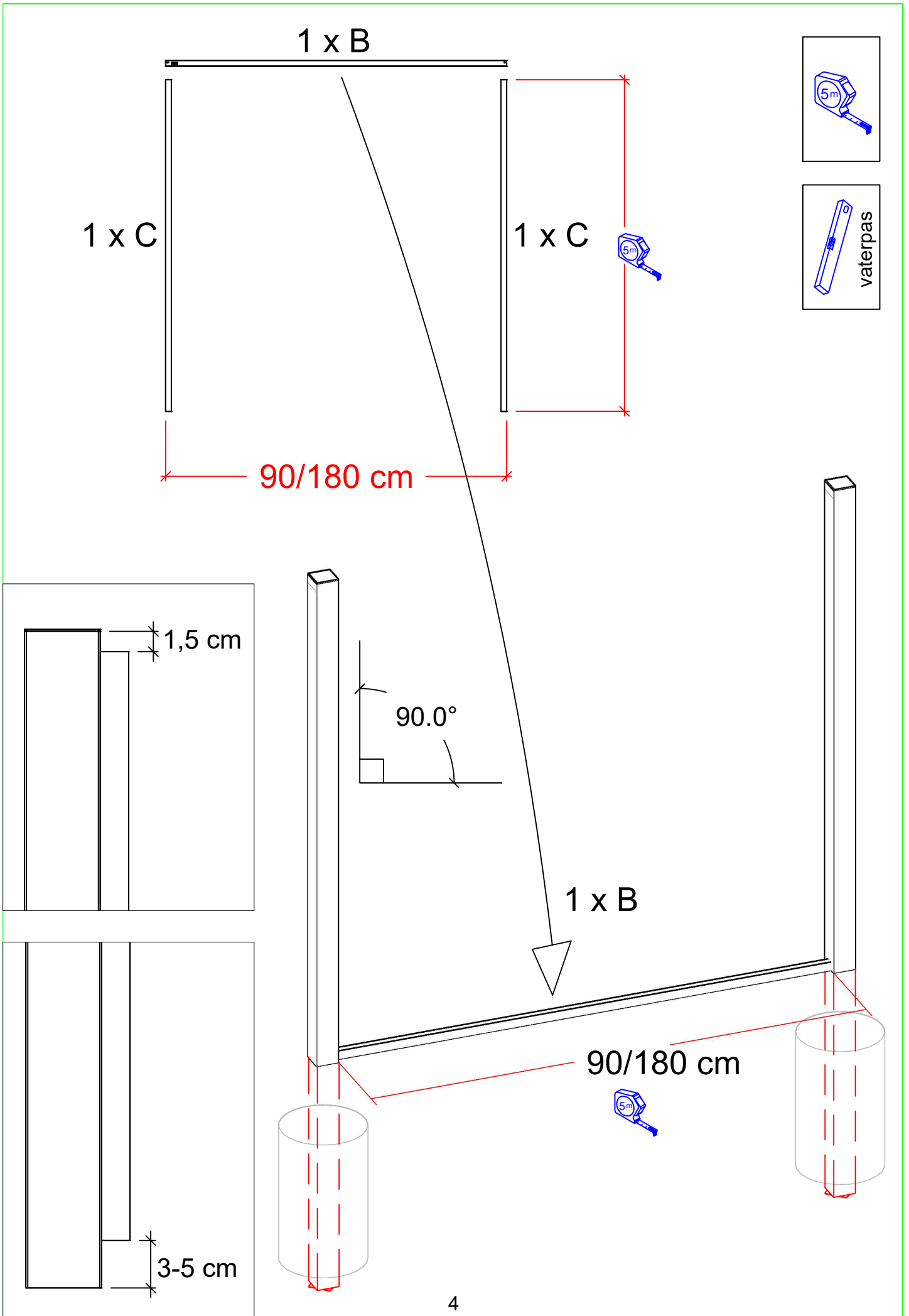

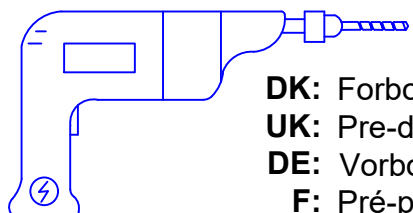
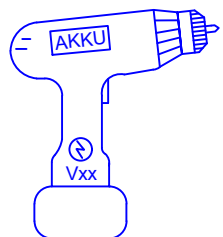
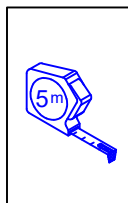

4,0 mm (3,5 mm)

- DK:** Forbores stille og roligt.
- UK:** Pre-drill carefully.
- DE:** Vorbohren vorsichtig und langsam.
- F:** Pré-percer soigneusement.
- B/NL:** Wordt kalm en rustig voorgeboord.
- FIN:** Pora reiät rauhallisesti.
- S:** Förborra lugnt och försiktigt.

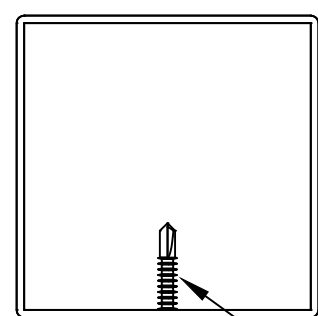
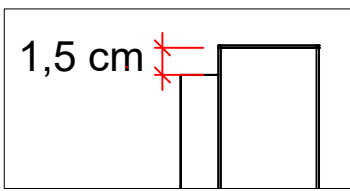
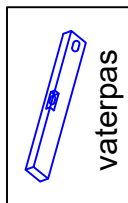

Monteret i stål.
 Assembled in steel.
 Montage auf Stahl.
 Monté sur acier.
 Samengesteld uit staal.
 Asennettu teräkseen.
 Monterat i stål.

17520-1
Skruer 5,5 x 25 mm
Screw 5,5 x 25 mm
Schrauben 5,5 x 25 mm
Des vis 5,5 x 25 mm
Schroeven 5,5 x 25 mm
Ruuvit 5,5 x 25 mm
Skruvar 5,5 x 25 mm

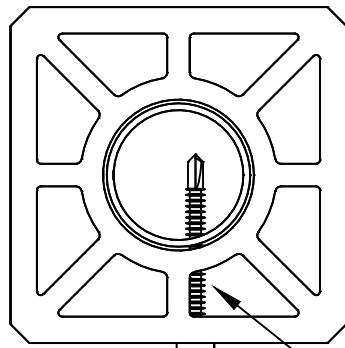
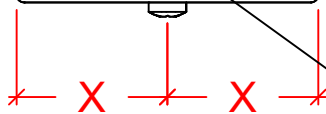

Monteret i Komposit.
 Assembled in composite.
 Montage auf Verbundwerkstoff.
 Monté sur matériau composite.
 Samengesteld composiet.
 Asennettu komposiittlien.
 Monterat i komposit.

17519-1
Skruer 5,5 x 50 mm
Screw 5,5 x 50 mm
Schrauben 5,5 x 50 mm
Des vis 5,5 x 50 mm
Schroeven 5,5 x 50 mm
Ruuvit 5,5 x 50 mm
Skruvar 5,5 x 50 mm

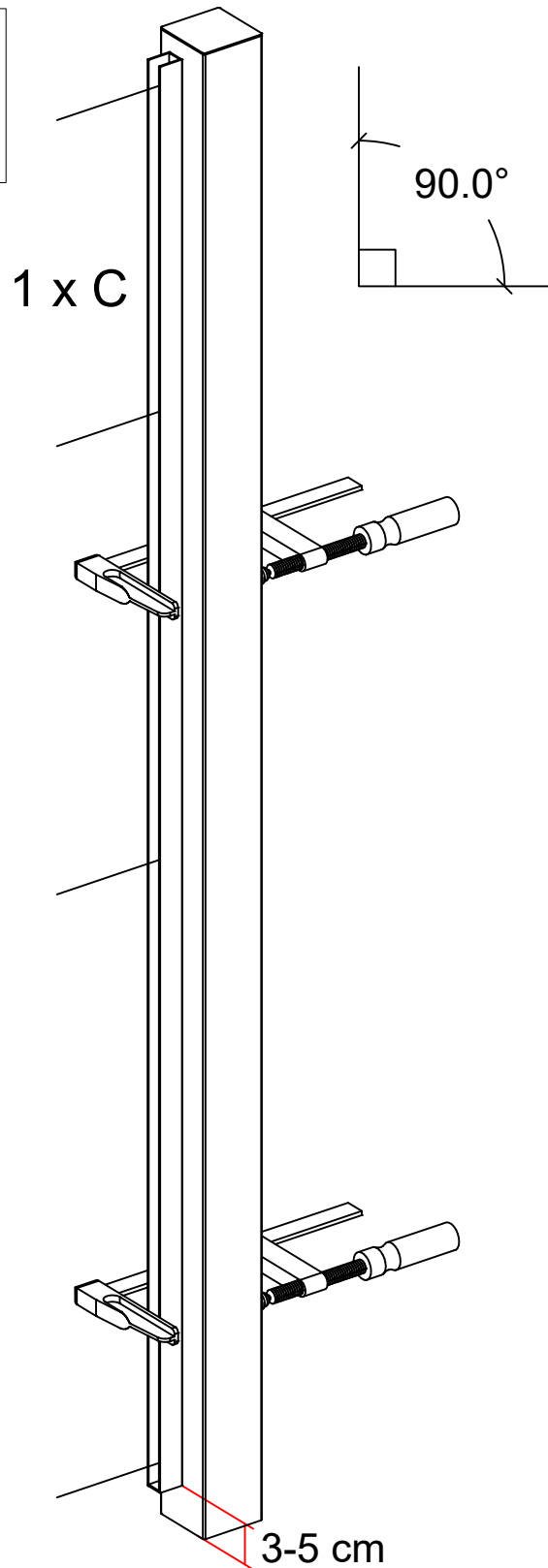

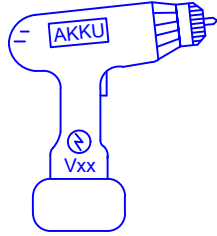
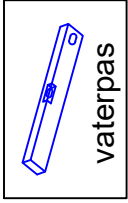
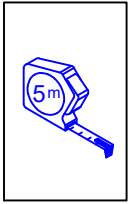

4,0 mm (3,5 mm)

DK: Forbores stille og roligt.

UK: Pre-drill carefully.

DE: Vorbohren vorsichtig und langsam.

F: Pré-percer soigneusement.

B/NL: Wordt kalm en rustig voorgeboord.

FIN: Poraa reiät rauhallisesti.

S: Förborra lugnt och försiktigt.

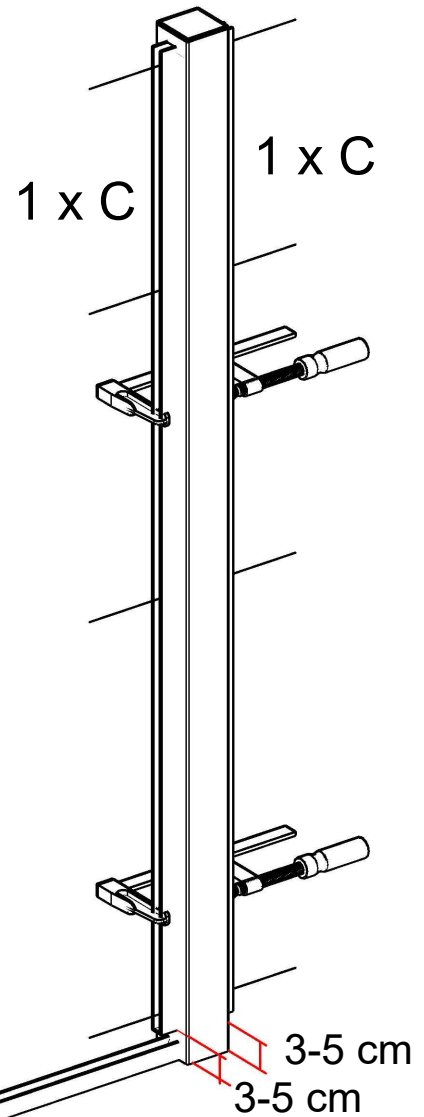
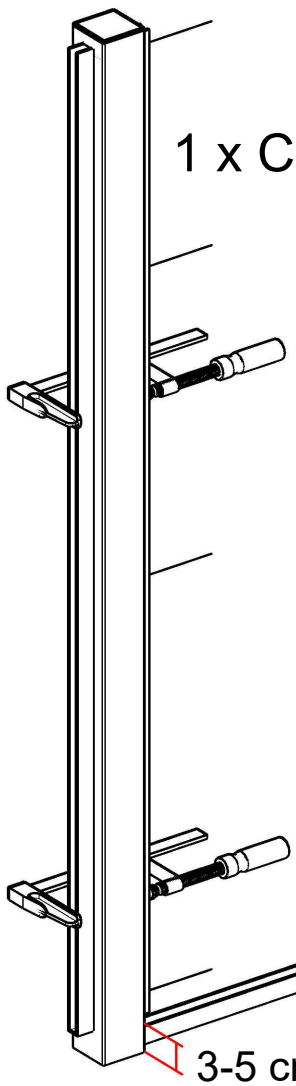
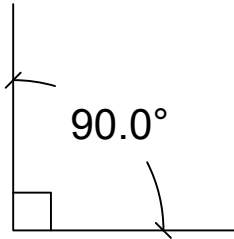

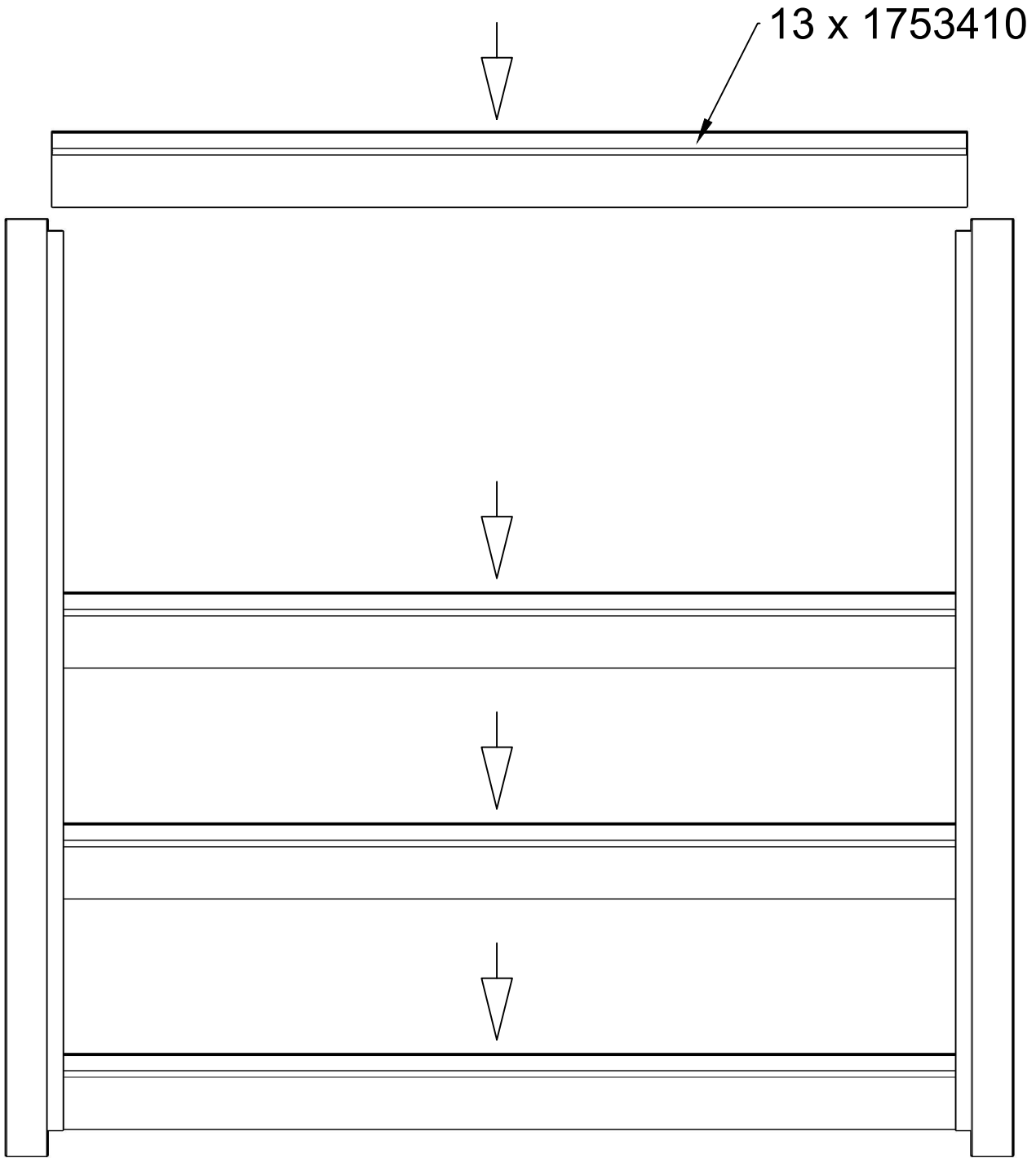
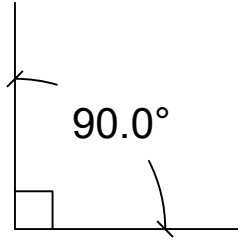
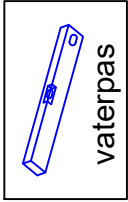
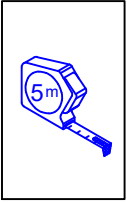

Monter toplisten.
 Mount the top strip.
 Obere Leisten montieren.
 Monter à nouveau la corniche.
 Hermonteer het bovenste profiel.
 Asenna yläkiskossa.
 Montera toplisten.

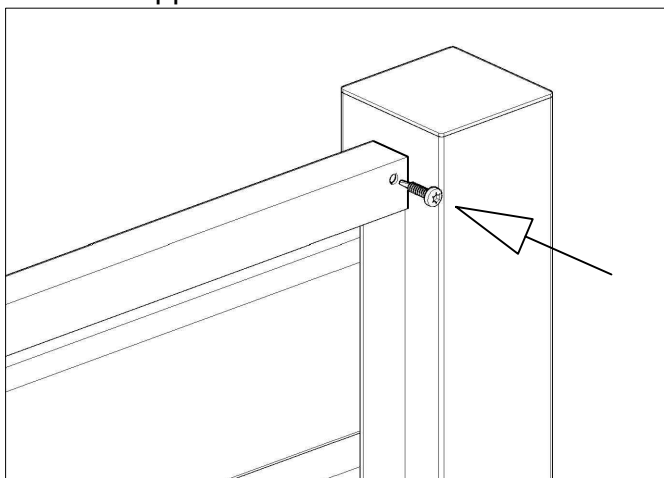
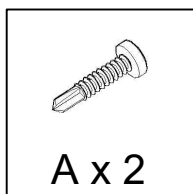

3,5 mm

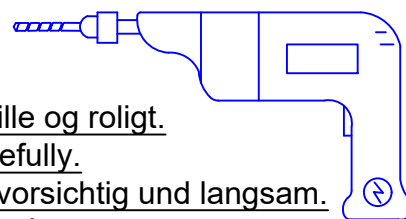

- DK:** Forbores stille og roligt.
- UK:** Pre-drill carefully.
- DE:** Vorbohren vorsichtig und langsam.
- F:** Pré-percer soigneusement.
- B/NL:** Wordt kalm en rustig voorgeboord.
- FIN:** Poraa reiät rauhallisesti.
- S:** Förborra lugnt och försiktigt.

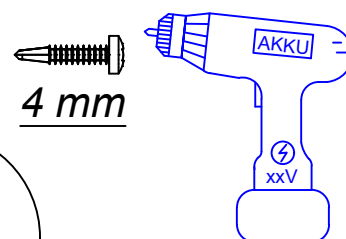

4 mm

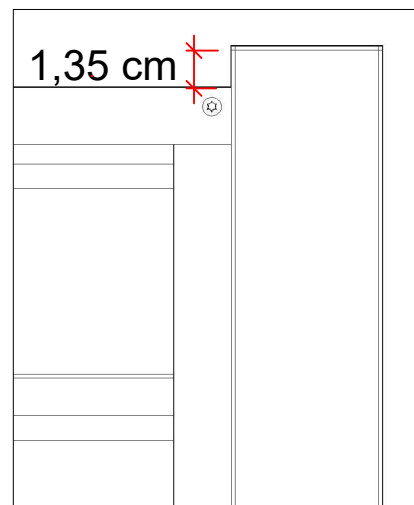
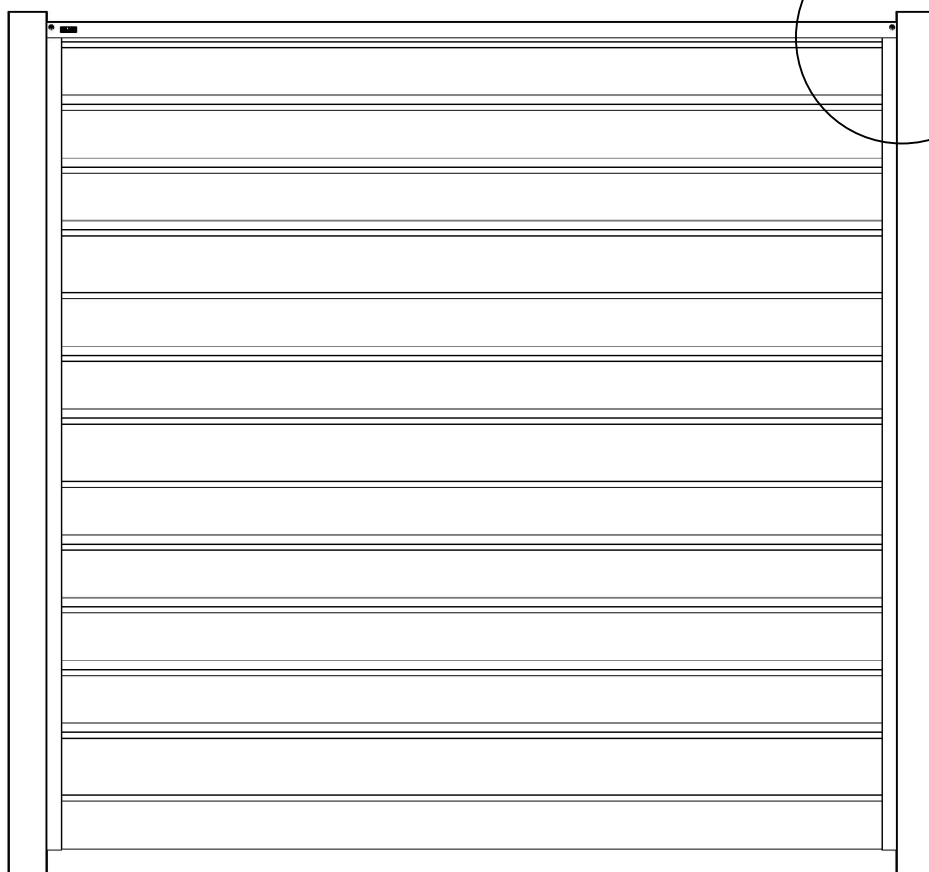

Se www.plus.dk for yderligere information og vedligehold af materialer.
 See www.plus.dk for additional information and maintenance of materials.
 Weitere Informationen sowie Wartungsanweisungen für die Materialien erhalten Sie auf www.plus.dk.
 Se reporter au site www.plus.dk pour de plus amples informations et pour l'entretien des matériaux.
 Zie www.plus.dk voor aanvullende informatie en het onderhoud van de materialen.
 Sivustolta www.plus.dk löydät lisätietoja ja materiaalien ylläpito-ohjeet.
 Se www.plus.dk för ytterligare information och materialunderhåll.

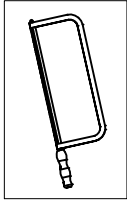
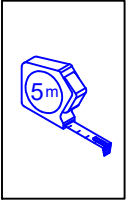

Zinkspray anbefales.
Zinc spray is recommended.
Zink-Spray wird empfohlen.
Zinc spray est recommandé.
Zinkspray aanbevolen.
Sinkki spray suositellaan.
Zink spray rekommenderas.

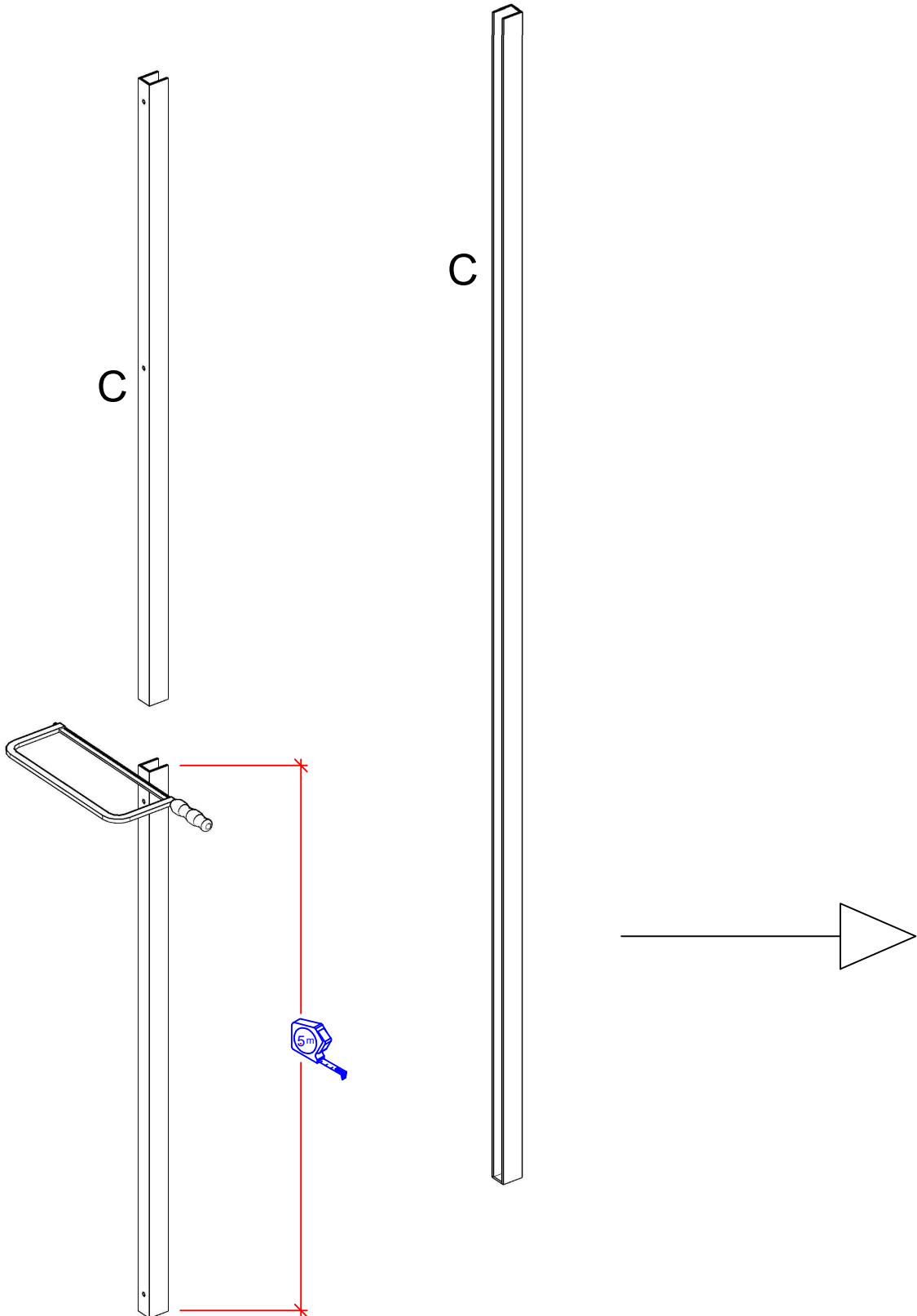

- DK:** Afstand mellem profiler og planker.
- UK:** Distance between structural sections and boards.
- DE:** Abstand zwischen den Profilen und Brettern.
- F:** Distance entre profils et planches.
- B/NL:** Afstand tussen de structuuronderdelen en panelen.
- FIN:** Ponttilautojen ja lankkujen välinen etäisyys.
- S:** Avstånd mellan profiler och plankor.

3,5 mm

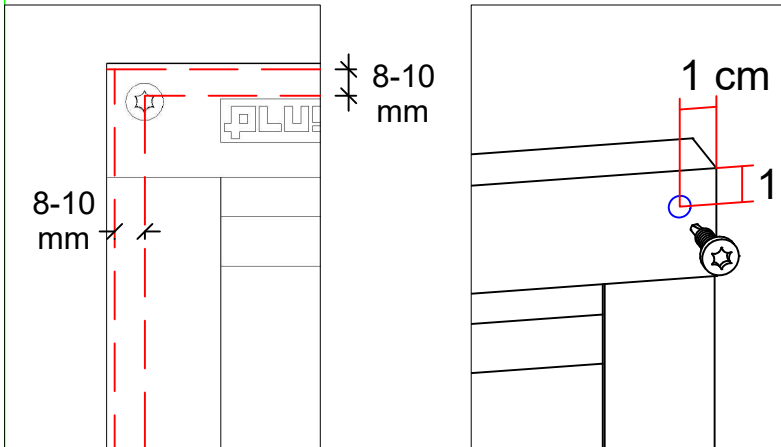
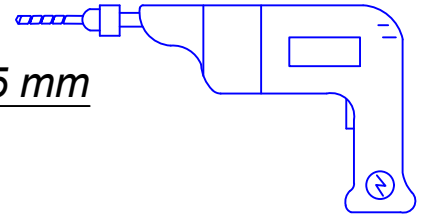

- DK:** Forbores stille og roligt.
- UK:** Pre-drill carefully.
- DE:** Vorbohren vorsichtig und langsam.
- F:** Pré-percer soigneusement.
- B/NL:** Wordt kalm en rustig vorgeboord.
- FIN:** Poraa reiät rauhallisesti.
- S:** Förborra lugnt och försiktigt.

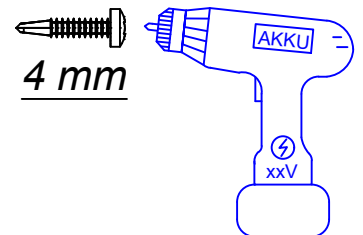

4 mm



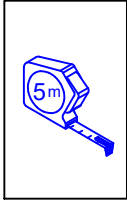
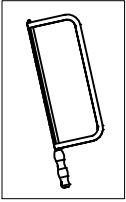

Zinkspray anbefales.
Zinc spray is recommended.
Zink-Spray wird empfohlen.
Zinc spray est recommandé.
Zinkspray aanbevolen.
Sinkki spray suositellaan.
Zink spray rekommenderas.

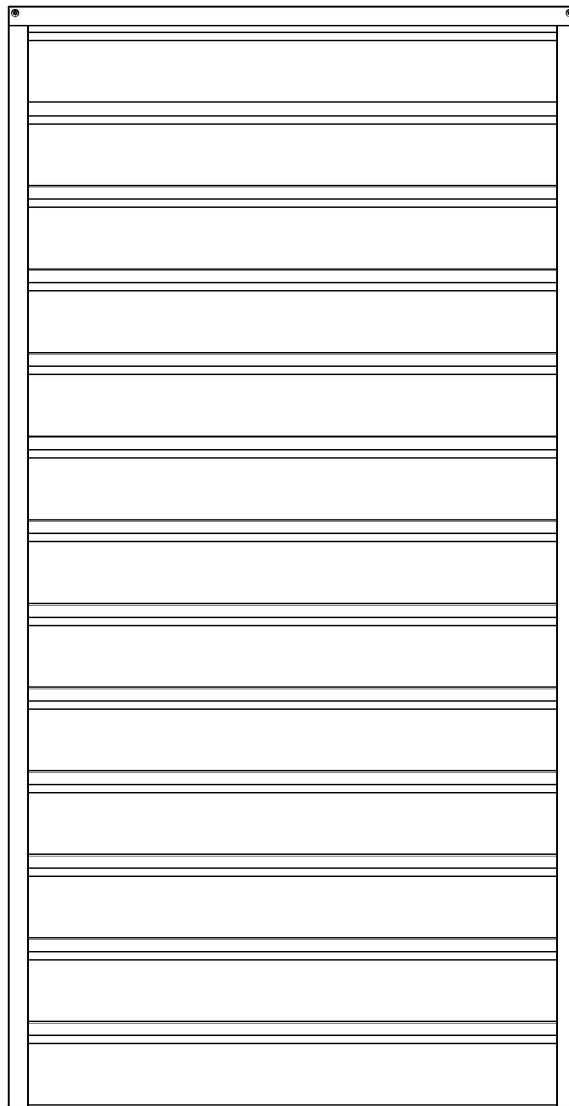
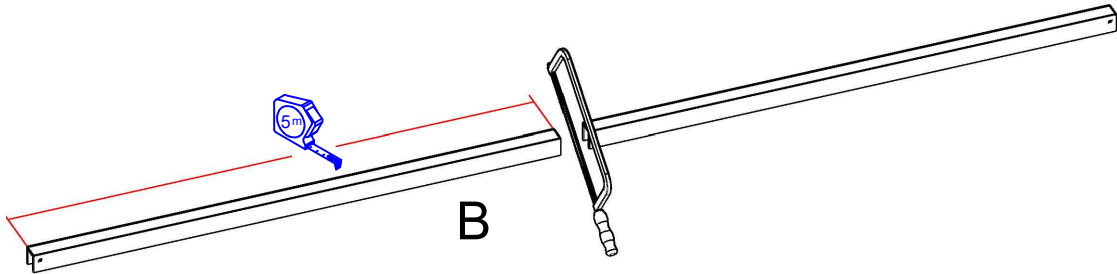

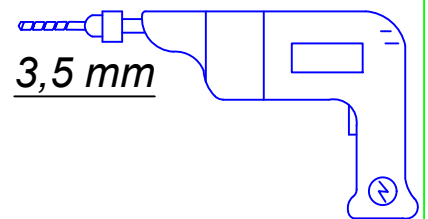
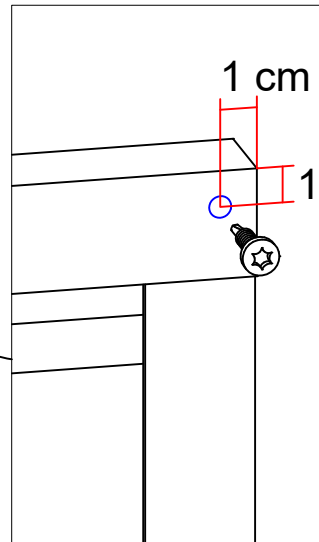
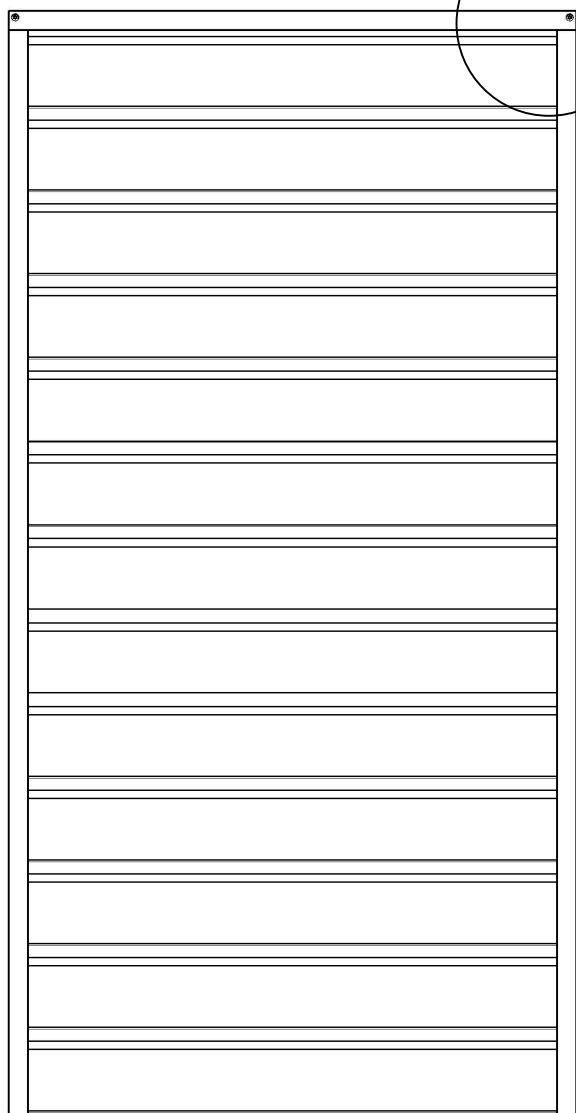
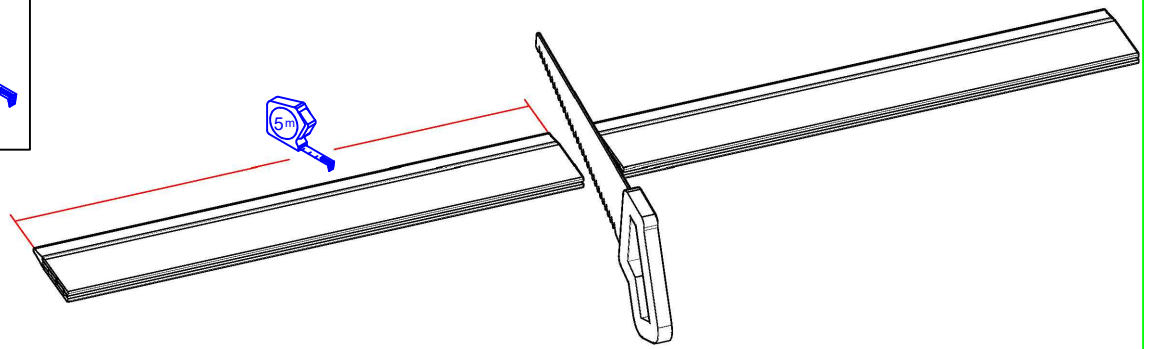
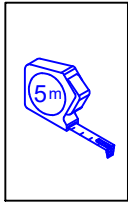
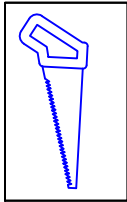

DK: Forbores stille og roligt.

UK: Pre-drill carefully.

DE: Vorbohren vorsichtig und langsam.

F: Pré-percer soigneusement.

B/NL: Wordt kalm en rustig voorgeboord.

FIN: Pora reiät rauhallisesti.

S: Förborra lugnt och försiktigt.

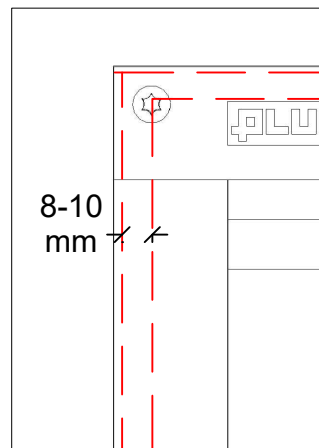

8-10
mm

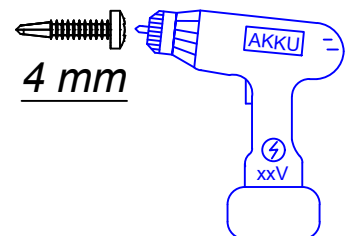

4 mm

DK: Afstand mellem profiler og planker.

UK: Distance between structural sections and boards.

DE: Abstand zwischen den Profilen und Brettern.

F: Distance entre profils et planches.

B/NL: Afstand tussen de structuuronderdelen en panelen.

FIN: Ponttilautojen ja lankkujen välinen etäisyys.

S: Avstånd mellan profiler och plankor.

